

# UM960L

GPS/BDS/GLONASS/Galileo/QZSS

All-constellation Multi-frequency

High Precision RTK Positioning Module

# Revision History

Version	Revision History	Date
R1.0	First release	Aug., 2022

## **Legal Right Notice**

This manual provides information and details on the products of Unicore Communication, Inc. ("Unicore") referred to herein.

All rights, title and interest to this document and the information such as data, designs, layouts contained in this manual are fully reserved, including but not limited to the copyrights, patents, trademarks and other proprietary rights as relevant governing laws may grant, and such rights may evolve and be approved, registered or granted from the whole information aforesaid or any part(s) of it or any combination of those parts.

Unicore holds the trademarks of "和芯星通", "UNICORECOMM" and other trade name, trademark, icon, logo, brand name and/or service mark of Unicore products or their product serial referred to in this manual (collectively "Unicore Trademarks").

This manual or any part of it, shall not be deemed as, either expressly, implied, by estoppel or any other form, the granting or transferring of Unicore rights and/or interests (including but not limited to the aforementioned trademark rights), in whole or in part.

## **Disclaimer**

The information contained in this manual is provided "as is" and is believed to be true and correct at the time of its publication or revision. This manual does not represent, and in any case, shall not be construed as a commitments or warranty on the part of Unicore with respect to the fitness for a particular purpose/use, the accuracy, reliability and correctness of the information contained herein.

Information, such as product specifications, descriptions, features and user guide in this manual, are subject to change by Unicore at any time without prior notice, which may not be completely consistent with such information of the specific product you purchase.

Should you purchase our product and encounter any inconsistency, please contact us or our local authorized distributor for the most up-to-date version of this manual along with any addenda or corrigenda.

## **UM960L User Manual**

# **Foreword**

This document describes the information of the hardware, package, specification and the use of Unicore UM960L modules.

## **Target Readers**

This document applies to technicians who possess the expertise on GNSS receivers.

# Contents

<b>1</b>	<b>INTRODUCTION .....</b>	<b>1</b>
1.1	Key Features.....	2
1.2	Key Specifications .....	2
1.3	Interfaces .....	4
<b>2</b>	<b>HARDWARE .....</b>	<b>5</b>
2.1	Dimensions .....	5
2.2	Pin Definition.....	7
2.3	Electrical Specifications.....	9
2.3.1	Absolute Maximum Ratings.....	9
2.3.2	Operational Conditions.....	10
2.3.3	IO Threshold .....	10
2.3.4	Antenna Feature.....	10
<b>3</b>	<b>HARDWARE DESIGN .....</b>	<b>11</b>
3.1	Antenna Feed Design .....	11
3.2	Grounding and Heat Dissipation .....	12
3.3	Power-on and Power-off .....	12
<b>4</b>	<b>PRODUCTION REQUIREMENT .....</b>	<b>13</b>
<b>5</b>	<b>PACKAGING .....</b>	<b>15</b>
5.1	Label Description.....	15
5.2	Product Packaging .....	15

# 1 Introduction

UM960L is a new generation of GNSS high precision positioning RTK module from Unicore. It supports all constellations and multiple frequencies, and can simultaneously track GPS L1/L2/L5 + BDS B1I/B2I/B3I + GLONASS L1/L2+Galileo E1/E5a/E5b + QZSS L1/L2/L5. The module is mainly used in geological hazard monitoring, deformation monitoring, and high precision GIS.

UM960L is based on NebulasIV™, a GNSS SoC which integrates RF-baseband and high precision algorithms. Besides, the SoC integrates a 2 GHz dual CPU, a high speed floating point processor and a RTK co-processor with 22 nm low power design, and it supports 1408 super channels. All these above enable stronger signal processing.

UM960L features a compact size of 16.0 mm × 12.2 mm. It adopts SMT pads, supports standard pick-and-place, and supports fully automated integration of reflow soldering.

Furthermore, UM960L supports interfaces such as UART, I<sup>2</sup>C\*, which meets the customers' needs in different applications.

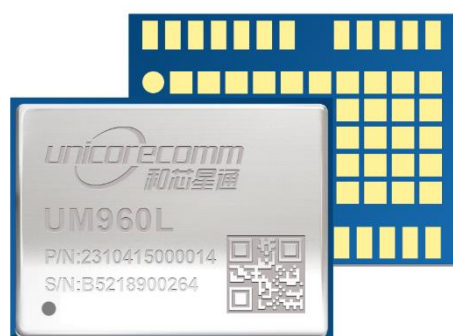

Figure 1-1 UM960L Module

---

\* Reserved interface, not supported currently.

## 1.1 Key Features

- High precision, compact size and low power consumption
- Based on the new generation GNSS SoC -NebulasIV™, with RF-baseband and high precision algorithms integrated
- 16.0 mm × 12.2 mm × 2.4 mm, surface-mount device
- Supports all-constellation multi-frequency on-chip RTK positioning solution
- Supports GPS L1/L2/L5 + BDS B1I/B2I/B3I + GLONASS L1/L2 + Galileo E1/E5b/E5a + QZSS L1/L2/L5
- All constellations and multiple frequencies RTK engine, and advanced RTK processing technology
- Independent track of each frequency, and 60 dB narrowband anti-jamming

## 1.2 Key Specifications

Table 1-1 Technical Specifications

Basic Information				
Channels	1408 channels, based on NebulasIV™			
Constellations	GPS/BDS/GLONASS/Galileo/QZSS			
Frequency	GPS: L1C/A, L2P(W), L2C, L5			
	BDS: B1I, B2I, B3I			
	GLONASS: L1C/A, L2C/A			
	Galileo: E1, E5b, E5a			
QZSS: L1, L2, L5				
Power				
Voltage	+3.0 V to +3.6 V DC			
Power Consumption	410 mW (Typical)			
Performance				
Positioning Accuracy	Single Point Positioning (RMS)	Horizontal: 1.5 m		
		Vertical: 2.5 m		
	DGPS (RMS)	Horizontal: 0.4 m		
	Vertical: 0.8 m			
	RTK (RMS)	Horizontal: 0.8 cm + 1 ppm		
		Vertical: 1.5 cm + 1 ppm		
Observation Accuracy (RMS)	BDS	GPS	GLONASS	Galileo
B1I/ L1C/A /G1/E1 Pseudorange	10 cm	10 cm	10 cm	10 cm
B1I/ L1C/A /G1/E1 Carrier Phase	1 mm	1 mm	1 mm	1 mm

## UM960L User Manual

B2I/L2P/G2/E5b Pseudorange	10 cm	10 cm	10 cm	10 cm
B2I/L2P/G2/E5b Carrier Phase	1 mm	1 mm	1 mm	1 mm
Time Accuracy (RMS)	20 ns			
Velocity Accuracy (RMS)	0.03 m/s			
Time to First Fix (TTFF)	Cold Start < 30 s			
Initialization Time	< 5 s (Typical)			
Initialization Reliability	> 99.9%			
Data Update Rate	5 Hz Positioning			
Differential Data	RTCM 3.0, 3.2, 3.3			
Data Format	NMEA-0183; Unicore			
<b>Physical Specifications</b>				
Package	24 pin LGA			
Dimensions	16.0 mm × 12.2 mm × 2.4 mm			
<b>Environmental Specifications</b>				
Operating Temperature	-40 °C to +85 °C			
Storage Temperature	-55 °C to +95 °C			
Humidity	95% No condensation			
Vibration	GJB150.16A-2009; MIL-STD-810F			
Shock	GJB150.18A-2009; MIL-STD-810F			
<b>Functional Ports</b>				
UART x 3				
I <sup>2</sup> C* x 1				

\* Reserved interface, not supported currently.



## 1.3 Interfaces

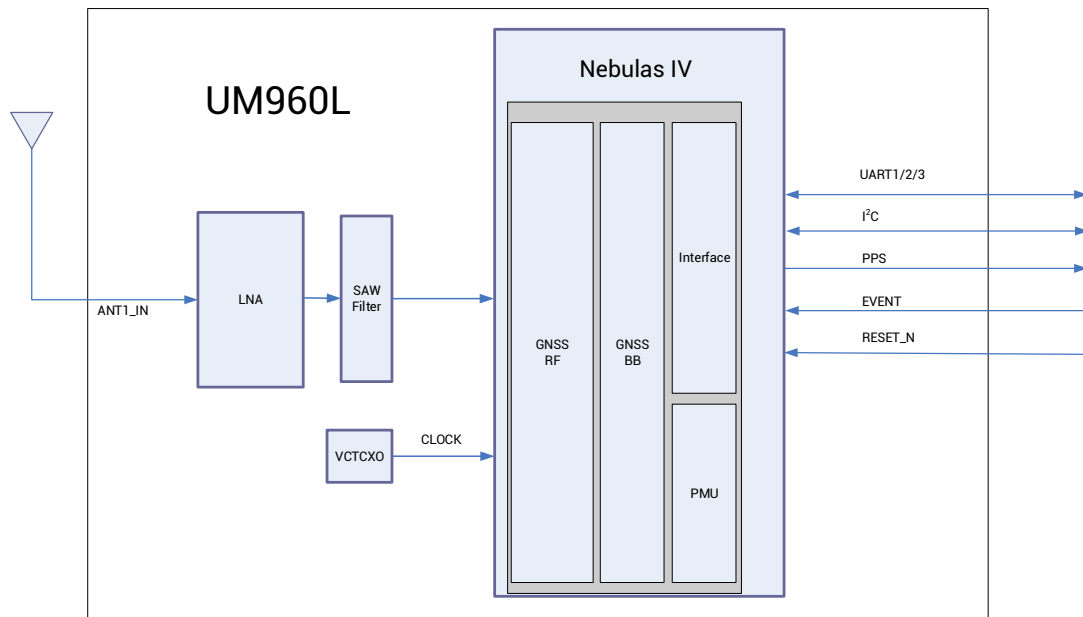

Figure 1-2 UM960L Block Diagram

- RF Part

The receiver gets filtered and enhanced GNSS signal from the antenna via a coaxial cable. The RF part converts the RF input signals into the IF signal, and converts IF analog signal into digital signals required for NebulasIV™ chip.

- NebulasIV™ SoC

NebulasIV™ is UNICORECOMM's new generation high precision GNSS SoC with 22 nm low power design, supporting all constellations, multiple frequencies and 1408 super channels. It integrates a 2 GHz dual CPU, a high speed floating point processor and an RTK co-processor, which can fulfill the high precision baseband processing and RTK positioning independently.

- 1PPS

UM960L outputs 1 PPS with adjustable pulse width and polarity.

- Event

UM960L provides 1 Event Mark Input with adjustable frequency and polarity.

- Reset (RESET\_N)

Active LOW, and the active time should be no less than 5 ms.

## 2 Hardware

### 2.1 Dimensions

Table 2-1 Dimensions

Symbol	Min. (mm)	Typ. (mm)	Max. (mm)
A	15.80	16.00	16.50
B	12.00	12.20	12.70
C	2.20	2.40	2.60
D	0.90	1.00	1.10
E	0.20	0.30	0.40
F	1.40	1.50	1.60
G	1.00	1.10	1.20
H	0.70	0.80	0.90
N	2.90	3.00	3.10
P	1.30	1.40	1.50
R	0.99	1.00	1.10
X	0.72	0.82	0.92
$\phi$	0.99	1.00	1.10

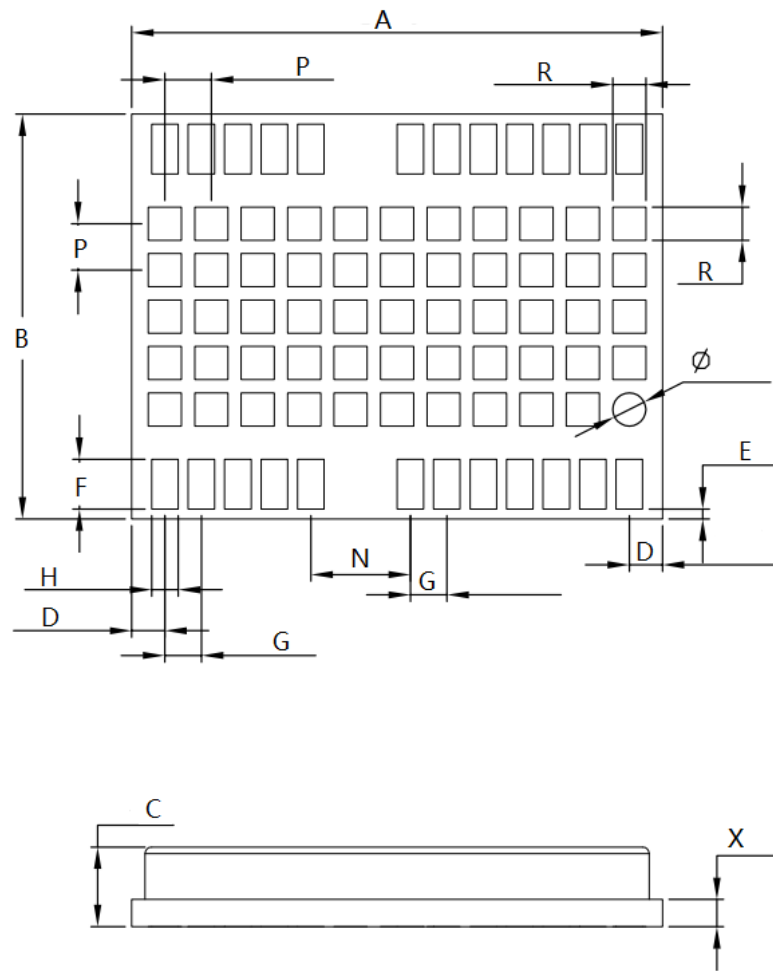

Figure 2-1 UM960L Mechanical Dimensions

## 2.2 Pin Definition

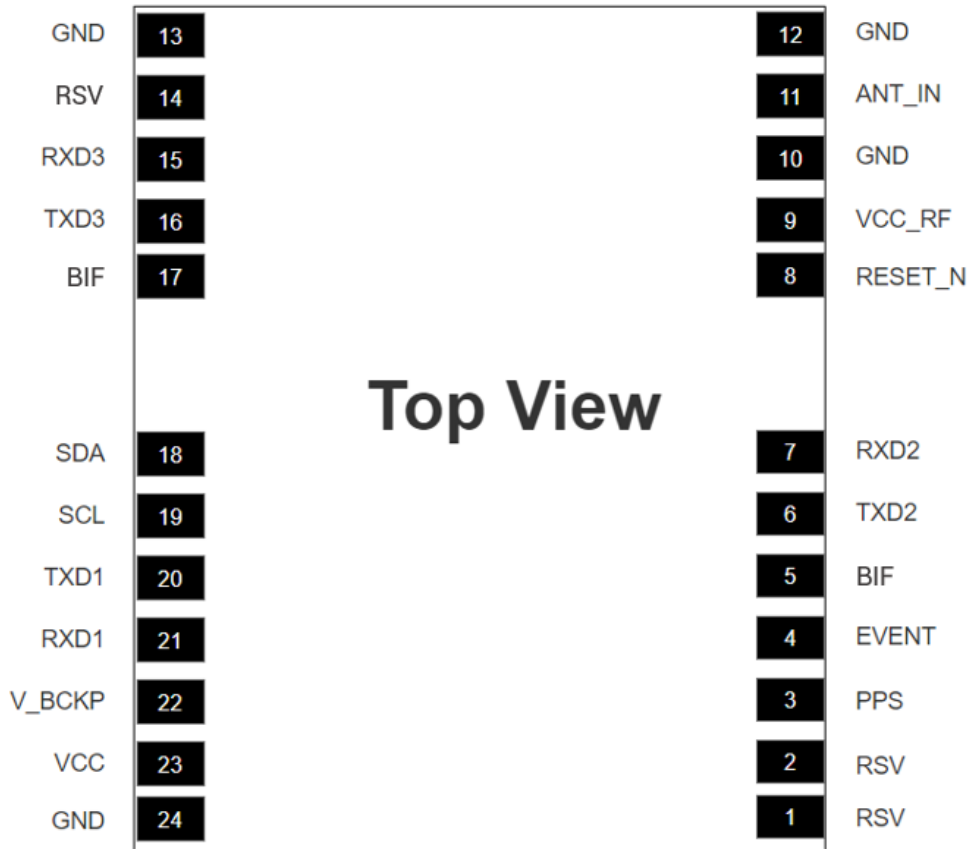

Figure 2-2 UM960L Pin Definition

Table 2-2 Pin Definition

No.	Pin	I/O	Description
1	RSV	—	Reserved, must be floating; cannot connect ground or power supply or peripheral I/O
2	RSV	—	Reserved, must be floating; cannot connect ground or power supply or peripheral I/O
3	PPS	O	Pulse per second
4	EVENT	I	Event Mark
5	BIF	—	Built-in function; recommended to add a through-hole testing point and a 10 kΩ pull-up resistor; cannot connect ground or power supply or peripheral I/O, but can be floating.
6	TXD2	O	UART2 transmitting data
7	RXD2	I	UART2 receiving data

No.	Pin	I/O	Description
8	RESET_N	I	System reset Active Low
9	VCC_RF <sup>1</sup>	O	External LNA power supply
10	GND	—	Ground
11	ANT_IN	I	GNSS antenna signal input
12	GND	—	Ground
13	GND	—	Ground
14	RSV	—	Reserved, must be floating; cannot connect ground or power supply or peripheral I/O
15	RXD3	I	UART3 receiving data
16	TXD3	O	UART3 transmitting data
17	BIF	—	Built-in function; recommended to add a through-hole testing point and a 10 kΩ pull-up resistor; cannot connect ground or power supply or peripheral I/O, but can be floating.
18	SDA	I/O	I <sup>2</sup> C data
19	SCL	I/O	I <sup>2</sup> C clock
20	TXD1	O	UART1 transmitting data
21	RXD1	I	UART1 receiving data
22	V_BCKP <sup>2</sup>	I	When the main power supply VCC is cut off, V_BCKP supplies power to RTC and relevant register. Level requirements: 2.0 V ~ 3.6 V, and the working current is less than 60 μA at 25 °C. If you do not use the hot start function, connect V_BCKP to VCC. Do NOT connect it to ground or leave it floating.
23	VCC	I	Supply voltage
24	GND	—	Ground

<sup>1</sup> Not recommended to take VCC\_RF as ANT\_BIAS to feed the antenna See section 3.1 for more details.

<sup>2</sup> Not supported currently, and keep this pin floating.

## 2.3 Electrical Specifications

### 2.3.1 Absolute Maximum Ratings

Table 2-3 Absolute Maximum Ratings

Parameter	Symbol	Min.	Max.	Unit
Power Supply (VCC)	VCC	-0.3	3.6	V
Voltage Input	V <sub>in</sub>	-0.3	3.6	V
GNSS Antenna Signal Input	ANT_IN	-0.3	6	V
RF Input Power	ANT_IN input		+10	dBm
Consumption of Antenna	power			
External LNA Power Supply	VCC_RF	-0.3	3.6	V
VCC_RF Output Current	ICC_RF		100	mA
Storage Temperature	T <sub>stg</sub>	-55	95	°C

## 2.3.2 Operational Conditions

Table 2-4 Operational Conditions

Parameter	Symbol	Min.	Typ.	Max.	Unit	Condition
Power Supply (VCC)	VCC	3.0	3.3	3.6	V	
Maximum Ripple Voltage	$V_{rpp}$	0		50	mV	
Working Current <sup>3</sup>	$I_{opr}$		109	218	mA	VCC = 3.3 V
VCC_RF Output Voltage	VCC_RF		VCC-0.1		V	
VCC_RF Output Current	ICC_RF			50	mA	
Operating Temperature	$T_{opr}$	-40		85	°C	
Power Consumption	P		410		mW	

## 2.3.3 IO Threshold

Table 2-5 IO Threshold

Parameter	Symbol	Min.	Typ.	Max.	Unit	Condition
Low Level Input Voltage	$V_{in\_low}$	0		$VCC \times 0.2$	V	
High Level Input Voltage	$V_{in\_high}$	$VCC \times 0.7$		$VCC + 0.2$	V	
Low Level Output Voltage	$V_{out\_low}$	0		0.45	V	$I_{out} = 4 \text{ mA}$
High Level Output Voltage	$V_{out\_high}$	$VCC - 0.45$		VCC	V	$I_{out} = 4 \text{ mA}$

## 2.3.4 Antenna Feature

Table 2-6 Antenna Feature

Parameter	Symbol	Min.	Typ.	Max.	Unit	Condition
Optimum Input Gain	$G_{ant}$	18	30	36	dB	

<sup>3</sup> Since the product has capacitors inside, inrush current occurs during power-on. You should evaluate in the actual environment in order to check the effect of the supply voltage drop caused by inrush current in the system.

## 3 Hardware Design

### 3.1 Antenna Feed Design

UM960L just supports feeding the antenna from the outside of the module rather than the inside. It is recommended to use devices with high power and that can withstand high voltage. Gas discharge tube, varistor, TVS tube and other high-power protective devices may also be used in the power supply circuit to further protect the module from lightning strike and surge.

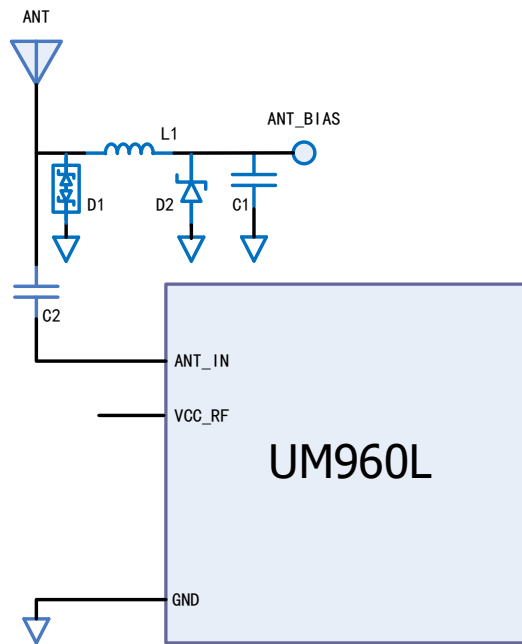

Figure 3-1 UM960L External Antenna Feed Reference Circuit

#### Remarks:

- L1: feed inductor, 68nH RF inductor in 0603 package is recommended;
- C1: decoupling capacitor, it is recommended to connect two capacitors of 100nF/100pF in parallel;
- C2: DC blocking capacitor, recommended 100pF capacitor;
- Not recommended to take VCC\_RF as ANT\_BIAS to feed the antenna (VCC\_RF is not optimized for the anti-lightning strike and anti-surge due to the compact size of the module)
- D1: ESD diode, choose the ESD protection device that supports high frequency signals (above 2000 MHz)
- D2: TVS diode, choose the TVS diode with appropriate clamping specification according to the requirement of feed voltage and antenna voltage



## 3.2 Grounding and Heat Dissipation

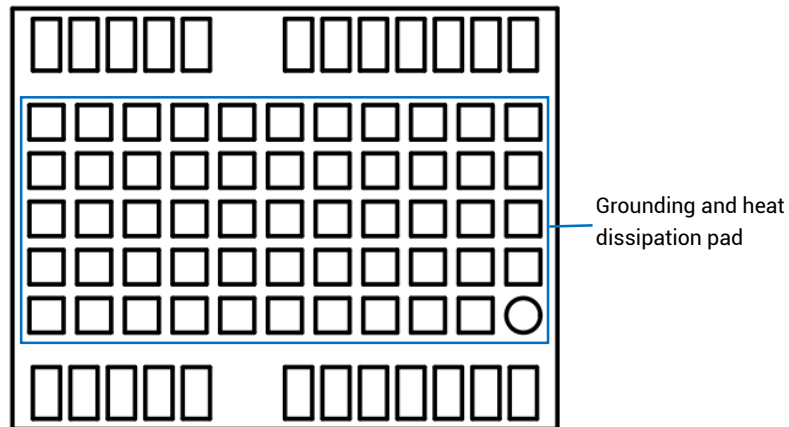

Figure 3-2 Grounding and Heat Dissipation Pad

The 55 pads in the rectangle in Figure 3-2 are for grounding and heat dissipation.

In the PCB design, they must connect to a large sized ground to strengthen the heat dissipation.

## 3.3 Power-on and Power-off

### VCC

- The VCC initial level when power-on is less than 0.4 V and it has good monotonicity. The voltages of undershoot and ringing are within 5% VCC.
- VCC power-on waveform: The time interval from 10% rising to 90% must be within 100  $\mu$ s to 1 ms.
- Power-on time interval: The time interval between the VCC < 0.4 V (after power-off) to the next power-on must be larger than 500 ms.

### V\_BCKP

- The V\_BCKP initial level when power-on is less than 0.4 V and it has good monotonicity. The voltages of undershoot and ringing are within 5% V\_BCKP.
- V\_BCKP power-on waveform: The time interval from 10% rising to 90% must be within 100  $\mu$ s to 1 ms.
- Power-on time interval: The time interval between the V\_BCKP < 0.4 V (after power-off) to the next power-on must be larger than 500 ms.

## 4 Production Requirement

Recommended soldering temperature curve is as follows:

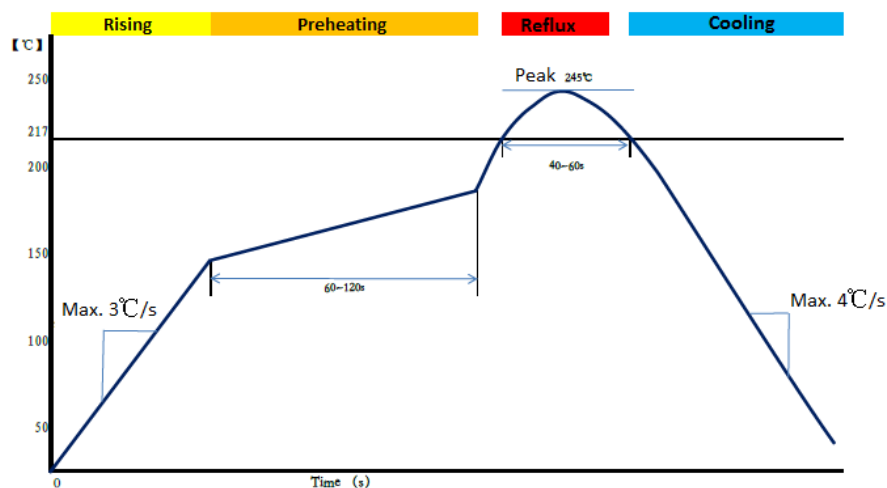

Figure 4-1 Soldering Temperature (Lead-free)

### Temperature Rising Stage

- Rising slope: Max. 3 °C/s
- Rising temperature range: 50 °C to 150 °C

### Preheating Stage

- Preheating time: 60 s to 120 s
- Preheating temperature range: 150 °C to 180 °C

### Reflux Stage

- Over melting temperature (217 °C) time: 40 s to 60 s
- Peak temperature for soldering: no higher than 245 °C

### Cooling Stage

- Cooling slope: Max. 4 °C/s



- In order to prevent falling off during soldering of the module, do not solder it on the back of the board during design, that is, better not go through soldering cycle twice.
- The setting of soldering temperature depends on many factors of the factory, such as board type, solder paste type, solder paste thickness, etc. Please also refer to the relevant IPC standards and indicators of solder paste.
- Since the lead soldering temperature is relatively low, if using this method, please give priority to other components on the board.
- The opening of the stencil needs to meet your design requirement and comply to the examine standards. The thickness of the stencil is recommended to be 0.15 mm.

## 5 Packaging

### 5.1 Label Description



Figure 5-1 Label Description

### 5.2 Product Packaging

The UM960L module uses carrier tape and reel (suitable for mainstream surface mount devices), packaged in vacuum-sealed aluminum foil antistatic bags, with a desiccant inside to prevent moisture. When using reflow soldering process to solder modules, please strictly comply with IPC standard to conduct humidity control. As packaging materials such as the carrier tape can only withstand the temperature of 55 °C, modules shall be removed from the package during baking.



Figure 5-2 UM960L Package

Table 5-1 Package Description

Item	Description
<b>Module Number</b>	500 pieces/reel
<b>Reel Size</b>	Tray: 13" External diameter: 330 mm Internal diameter: 100 mm Width: 24 mm Thickness: 2.0 mm
<b>Carrier Tape</b>	Space between (center-to-center distance): 20 mm

The UM960L is rated at MSL level 3. Refer to the relevant IPC/JEDEC J-STD-033 standards for the package and operation requirements. You may access to the website [www.jedec.org](http://www.jedec.org) to get more information.

The shelf life of the UM960L module packaged in vacuum-sealed aluminum foil antistatic bags is one year.

和芯星通科技（北京）有限公司

**Unicore Communications, Inc.**

北京市海淀区丰贤东路7号北斗星通大厦三层  
F3, No.7, Fengxian East Road, Haidian, Beijing, P.R.China,  
100094

[www.unicorecomm.com](http://www.unicorecomm.com)

Phone: 86-10-69939800

Fax: 86-10-69939888

info@unicorecomm.com



[www.unicorecomm.com](http://www.unicorecomm.com)