



INSTALLATION AND OPERATION

USER MANUAL

WWW.UNICORECOMM.COM

UM220-IV M0

Industry Grade Multi-GNSS Positioning Module

Copyright© 2009-2022, Unicore Communications, Inc.
Data subject to change without notice.



Revision History

Version	Revision	Date
Ver.1.0.0	Primary version	Jun.2018
Ver.1.0.1	Alpha release, Revised Pin definition	Oct.2018
Ver.1.0.2	Revised module size	Dec.2018
Ver.1.0.4	Beta release, align with Chinese version 1.0.4	Aug. 2019
R1.1	Chapter 6.2: add shelf life	Sep. 2019
R1.2	Chapter 6.2: revise the MSL instructions Add CE logo	Jan. 2020
R1.3	Add a footnote to elaborate CEP	Oct. 2020
R2	Hardware version 2.3 released, update the related parameters	Dec. 2020
R2.1	Add the descriptions of SMT stencil	Jun. 2021
R2.2	Update power supply VCC and V_BCKP; Add different PN information and corresponding solutions to avoid string power	Nov. 2021
R2.3	Add the Note in Section 4.3	Nov. 2021
R2.4	If hot start is not used, connect V_BCKP to VCC. Revise the VSWR in section 1.2	Nov. 2022

Disclaimer

Information in this document is subject to change without notices and does not represent a commitment on the part of Unicore Communication, Inc. No part of this manual may be reproduced or transmitted in any form or by any means, electronic or mechanical, including photocopying and recording, for any purpose without the express written permission of a duly authorized representative of Unicore Communications, Inc. The information contained within this manual is believed to be true and correct at the time of publication.

© Copyright 2009-2022 Unicore Communications, Inc. All rights reserved.

Foreword

This document offers you information in the features of the hardware, the installation, specification and use of UNICORECOMM UM220-IV M0 product.

Readers It Applies to

This document is applied to the technicians who know GNSS Receiver to some extent but not to the general readers.

Structure of the Document

This document includes the following:

Introduction: Briefly explaining the functions, performances and installing of the product

Installation: Containing the list of the product package and the details of product installation

Technical Specification: Offering technical specifications of the product

Hardware Specification: Offering all the information of hardware interface of the product

Module disassembly introduction

Package: Provide packing instructions of UM220-IV M0 modules



Contents

1	INTRODUCTION.....	1
1.1	OVERVIEW.....	1
1.2	KEY FEATURES.....	2
1.3	INTERFACE.....	3
2	PRODUCT INSTALLATION.....	4
2.1	INSTALLATION PREPARATION.....	4
2.2	HARDWARE INSTALLATION.....	5
3	TECHNICAL SPECIFICATIONS.....	6
3.1	ELECTRICAL SPECIFICATIONS.....	6
3.2	OPERATION CONDITION.....	6
3.3	DIMENSIONS.....	7
3.4	PIN DEFINITION (TOP VIEW).....	8
4	HARDWARE DESIGN.....	9
4.1	DESIGN IN CONSIDERATIONS.....	9
4.2	AVOID STRING POWER.....	10
4.3	ANTENNA.....	10
4.4	SERIAL PORT.....	11
5	DISASSEMBLY.....	12
6	PACKAGE.....	12
6.1	PRODUCT LABEL DESCRIPTION.....	12
6.2	PACKAGE DESCRIPTION.....	12
7	CLEAN.....	14
8	REFLOW SOLDERING.....	14

1 Introduction

1.1 Overview

UNICORECOMM UM220-IV M0 is a dual-system GNSS module. It is designed on the basis of UNICORECOMM's low power, multisystem, high performance SoC-UFirebird designed. It supports BDS B1+GPS L1 dual-system joint positioning and single system positioning. UM220-IV M0 is compact in size and uses SMT pads to support fully automatic integration of standard discharge and reflow soldering, especially suitable for low cost and low power consumption fields. The radio equipment is in compliance with Directive 2014/53/EU.

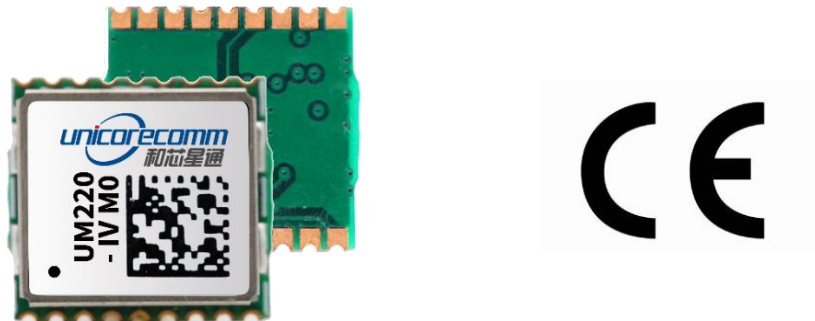

Figure 1-1 UM220-IV M0 Module

Model	PN	Grade		System			Interface		Data Updating Rate
		Industry	Automotive	GPS	BDS	GLONASS	UART1	UART2	
UM220-IV M0	2310408000024	•		•	•	•	•		1Hz
UM220-IV M0	2330322000028	•		•	•		•		1Hz

1.2 Key Features

Power	
Voltage	+3.0~3.6 VDC
Power Consumption	90mW
RF Input	
Input VSWR	≤2.5
Input Impedance	50Ω
Antenna Gain	15~30dB
Physical Characteristics	
Dimension	10.1*9.7*2.2mm
Environment	
Operating Temperature	-40°C ~ +85°C
Storage Temperature	-45°C ~ +90°C
RoHS	Compliant
Input/output Data Interface	
UART	1 UART, LVTTTL. Baud rate 4800~115200bps
GNSS Performance	
Frequency	BDS B1: 1561.098MHz GPS L1: 1575.42MHz
TTF	Cold Start: 28s Hot Start: 1s Reacquisition: 1s AGNSS ¹ : 4s
Positioning Accuracy ²	2.0m (dual-system horizontal, open sky) 3.5m (dual-system vertical, open sky)
Velocity Accuracy (RMS)	0.1m/s (dual-system, Open sky)

¹ Assist data input

² CEP, 50%

	BDS	GPS
Sensitivity	Tracking	-161dBm
	Acquisition	-146dBm
	Hot start	-154dBm
	Reacquisition	-157dBm
1PPS Accuracy (RMS)	20ns	
Data Updating Rate	1Hz	
Data Output	NMEA 0183, Unicore Protocol	

1.3 Interface

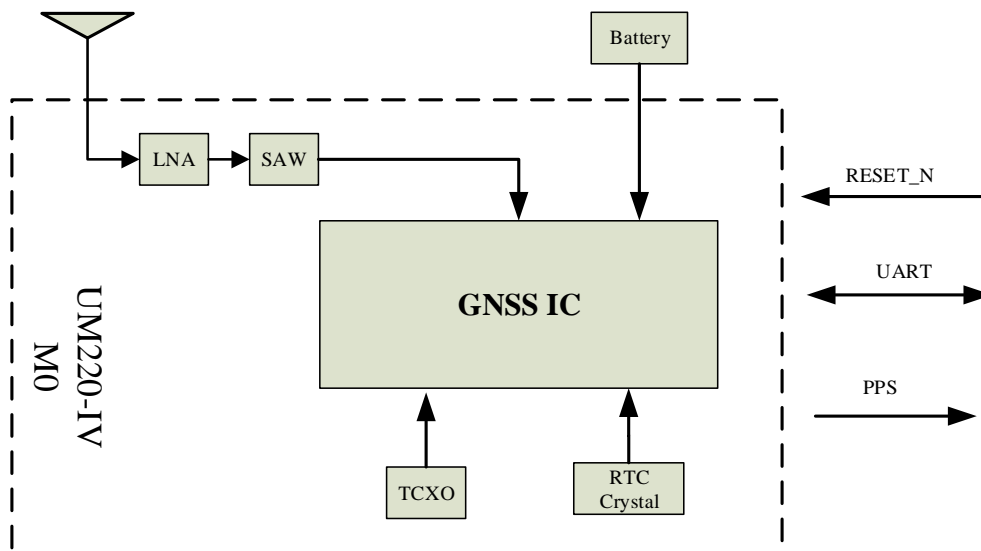

Figure 1-2 Structure Chart

UART

UM220-IV M0 module supports data transfer and firmware upgrade; the signal input/output level is LVTTTL. The default baud rate is 9600bps, which is adjustable, and can be configured up to 115200bps.

1PPS

UM220-IV M0 outputs 1PPS with adjustable pulse width and polarity.

2 Product Installation

2.1 Installation Preparation

UM220-IV M0 modules are Electrostatic Sensitive Devices and require special precautions when handling.

- Follow the steps in section 2.2 in the correct order.
- Electrostatic discharge (ESD) may cause damage to the device. All operations mentioned in this chapter should be carried out on an antistatic workbench, wear an antistatic wrist strap and use a conductive foam pad. If an antistatic workbench is not available, wear an antistatic wrist strap and connect the other end to a metal frame to play a role in anti-static.
- Hold the edge of the module, not in direct contact with the components.
- Please check carefully whether the module has obviously loose or damaged components. If you have questions, please contact us or your local dealer.

Figure 2-1 shows the typical installation of UM220-IV M0 EVK suites.

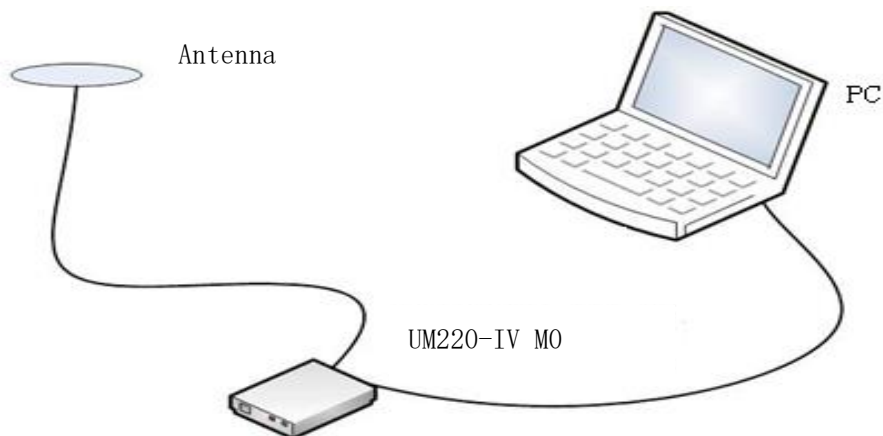

Figure 2-1

Please check the contents of the package carefully after receiving the package of UM220-IV M0:

- UM220-IV M0 EVK suite (with AC Adapter)
- UM220-IV M0 User manual.
- uSTAR application package.
- Antenna.
- Antenna connection cable
- Direct serial cable
- PC

Please keep the box and anti-static plastic bags for storage and handling.

2.2 Hardware Installation

After the above preparations are complete, follow the steps below to install:

Step 1: Make sure to take full anti-static measures, such as wearing an anti-static wrist strap, grounding the workbench;

Step 2: Open the UM220-IV M0 evaluation kit;

Step 3: Select the GNSS antenna with appropriate gain, fix it in the non-block area, using the appropriate cable to connect the antenna to UM220 EVK;

Step 4: Connect the PC to the EVK serial port through direct serial cable;

Step 5: Power the evaluation board and initialize the UM220-IV M0;

Step 6: Open the uSTAR

Step 7: Controlled the receiver through uSTAR to display constellations view, log messages, and receiver status.



3 Technical Specifications

3.1 Electrical Specifications

Absolute Maximum Ratings

Item	Pin	Min	Max	Unit	Condition
Power Supply (VCC)	Vcc	-0.5	3.6	V	
VCC Ripple	Vrpp		50	mV	
Digital IO	Vin	-0.5	Vcc +0.2	V	
Storage Temperature	Tstg	-45	90	°C	
MSD (MSL)	□Level 1 □Level 2 ■Level 3 □TBD				

3.2 Operation Condition

Item	Pin	Min	Typical Value	Max	Unit	Condition
Power Supply (VCC)	Vcc	3.0	3.3	3.6	V	
Peak Current	Iccp			53	mA	Vcc=3.0 V
Tracking Average Current	I _{ACC}	29	30	31	mA	Vcc=3.0V
Low Level Input Voltage	Vin_low			0.7	V	
High Level Input Voltage	Vin_high	1.2			V	
Low Level Output Voltage	Vout_low			0.4	V	I _{out} =-8 mA
High Level Output Voltage	Vout_high	Vcc-0.4			V	I _{out} =8 mA
Antenna Gain	Gant	15		30	dB	
Noise Figure	Nftot		2		dB	
Operation Temperature	Topr	-40		85	°C	

3.3 Dimensions

Table 3-1: Dimensions

Symbol	Min (mm)	Typical Value (mm)	Max (mm)
A	9.6	10.1	10.7
B	9.55	9.7	9.85
C	1.9	2.0	2.1
D	0.55	0.65	0.95
E	1.0	1.1	1.2
F	0.5	0.6	0.7
G	0.3	0.4	0.5
H	0.9	1.0	1.1
K	0.6	0.7	0.8
M	0.7	0.8	0.9

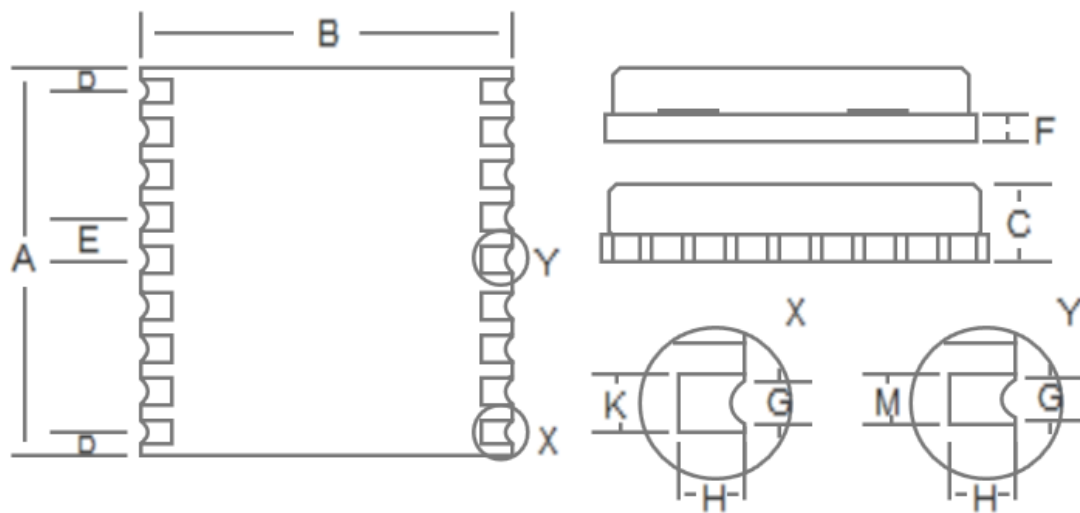

Figure 3-1 Mechanical Layout

3.4 Pin Definition (Top View)

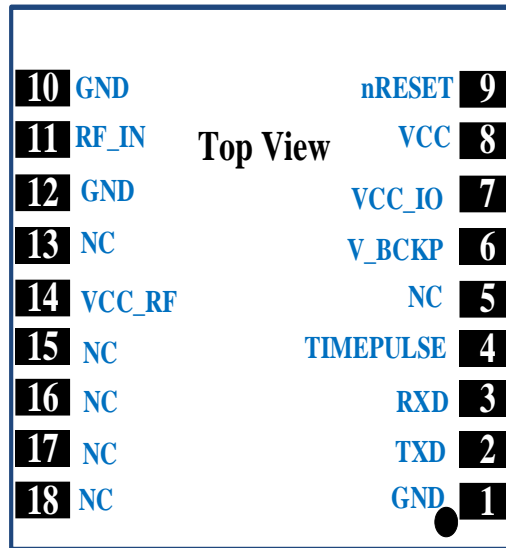

Figure 3-2 UM220-IV M0

No	Name	I/O	Electrical level	Description
1	GND	I		Ground
2	TXD	O	LVTTL	UART 1-TX
3	RXD	I	LVTTL	UART 1-RX
4	TIMEPULSE	O	LVTTL	1PPS
5	NC	I	LVTTL	Reserve
6	V_BCKP	I	1.65V~3.6V	Voltage for RTC. If you do not use the hot start function, connect V_BCKP to VCC. Do NOT connect it to ground or leave it floating.
7	VCC_IO	I	3.0V~3.6V	GPIO power supply
8	VCC	I	3.0V~3.6V	Main power
9	nRESET	I	LVTTL	For reset, Low level active, if you do not use the pin, please leave it hanging
10	GND	I		Ground
11	RF_IN	I		GNSS signal input (BDS B1+GPS L1)
12	GND	I		Ground
13	NC	O		Reserve
14	VCC_RF ³	O	=VCC	Output voltage RF section
15	NC	I/O		Reserve
16	NC	I/O		Reserve

³ VCC_RF does not have short circuit detection function;

No	Name	I/O	Electrical level	Description
17	NC	I/O		Reserve
18	NC	I/O		Reserve

4 Hardware Design

4.1 Design in Considerations

To make UM220-IV M0 work normally, you need to properly connect the following:

The Module VCC has good monotonicity. If the VCC power off and then on, the power off time must be more than 10ms.

- Connect all the GND pins to ground.
- Connect the RF_IN signal to the antenna, and the line will keep 50Ω impedance matching.
- Ensure COM1 is connected to a PC or an external processor, users can use this serial port to receive position data. COM1 is also necessary for firmware upgrades.

In order to obtain good performance, special concern should be paid during the design:

- Power supply: Stable and low ripple power is necessary for good performance. Make sure the peak to peak voltage ripple does not exceed 50mV.
 - Use LDO to ensure the purity of power supply
 - Try to place LDO close to the module in layout
 - Widen the power circuit or use copper pour surface to transmit current
 - Avoid walking through any high-power or high inductance devices such as a magnetic coil
- UART interfaces: Ensure that the signals and baud rate of main equipment match that of UM220-IV M0 module
- Antenna interface: Make sure the antenna impedance matches, and the cable is short without any kinks , try to avoid acute angles
- Antenna position: In order to ensure a good signal-to-noise ratio, the antenna

should be well isolated from any electromagnetic radiation source, especially an electromagnetic radiation in the frequency range of 1559 ~ 1605MHz

- Try to avoid designing in any circuits underneath UM220-IV M0
- This module is a temperature sensitive device. Dramatic changes in temperature will result in reduced performance, so keep it away as far as possible from any high-power high-temperature air and heating devices.

4.2 Avoid String Power

The module input ports of UM220-IV M0 include: RXD and GPIO. When the module is not powered on, if there is data input in the above ports, it will form a series of power on the module VCC. When the series voltage is higher than 1.6V, it may cause a failure of starting up when the module is powered on.

Solution:

When the module is not powered on, make sure that the IO port connected to the module is in a high-resistance state or a low level to avoid string power. Another solution is to connect a 1KΩ resistor in series to the serial port RX, and connect a 33Ω or 1KΩ resistor in series to TX (There is no need to connect any resistor to the TX of the module with PN 2310408000024). It is also recommended to connect a 4.7KΩ resistor in series to the Pin of other necessary PIOs.

4.3 Antenna

If UM220-IV M0 uses a +3V active antenna, it is recommended to use the VCC_RF pin output to power the antenna through a feed inductor.

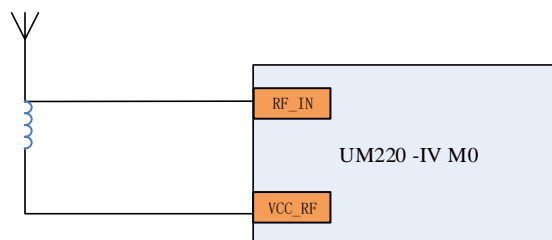

Figure 4-1 UM220-IV M0 Active Antenna +3V Solution

Note: If the user has a high requirement for ESD (> ±2000 V), the user should consider other method to feed the antenna rather than using the VCC_RF pin. In this case, it is recommended to choose a power supply chip with high ESD protection level. Gas discharge tube, varistor, TVS tube and other high-power protective devices may also be

used in the power supply circuit to further protect the module from ESD damage or other Electrical Over-Stress (EOS).

If the UM220-IV M0 uses an active antenna other than +3V, the bias voltage V_BIAS required by the antenna is supplied to the antenna through a feed inductor.

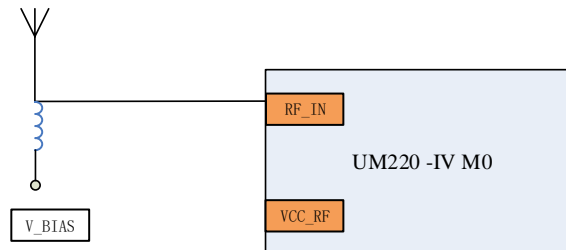

Figure 4-2 UM220-IV M0 Active Antenna (Other than +3V) Solution

If UM220-IV M0 uses a passive antenna, and the antenna is directly connected to RF_IN pin, the VCC_RF can be suspended. It should be noted that the use of passive antennas may cause a decrease in GNSS performance compared to active antennas.

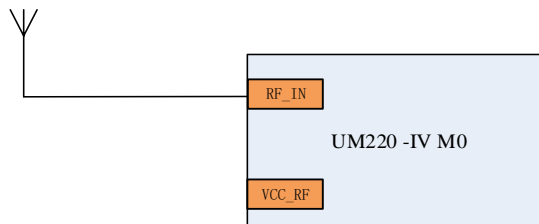

Figure 4-3 UM220-IV M0 Passive Antenna Solution

4.4 Serial Port

UM220-IV M0 has one LVTTTL serial port, for PC connection, please use a RS232 voltage level converter.

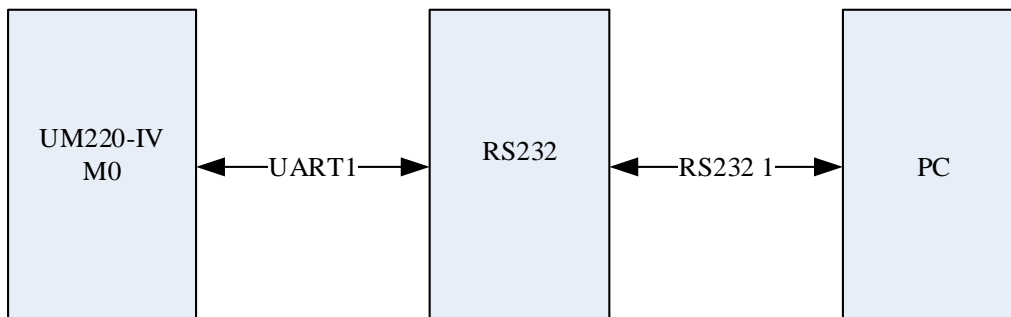

Figure 4-4 Connect COM to PC

5 Disassembly

When it is necessary to remove the module, it is recommended to melt the soldering tin of the pins on both sides of the module with an electric soldering iron and remove the module with tweezers. Do not use other means to remove the module (such as using a hot air gun to blow the module), may lead to module damage.

6 Package

6.1 Product Label Description

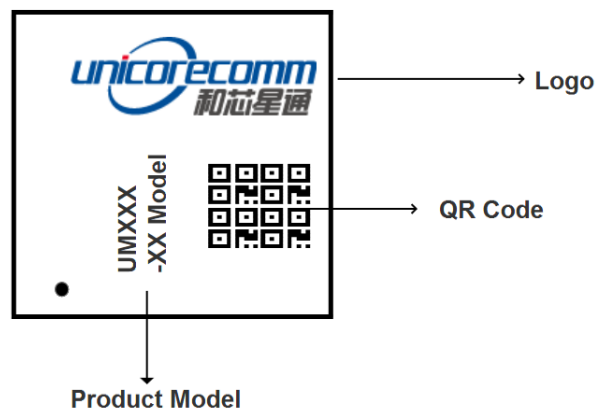

6.2 Package Description

The UM220-IV M0 modules are packaged in vacuum sealed aluminum foil anti-static bags with desiccant and moisture-proof agent. When using reflow welding process to weld modules, please strictly comply with IPC standard to conduct humidity control on modules. As packaging materials such as carrier belt can only withstand the temperature of 65 degrees Celsius, modules shall be removed from the packaging during baking.



Figure 6-1 UM220 package

Item	Description
Module	1000 pics/reel
Reel Size	Workpiece tray: 13" External diameter 330mm, internal diameter 100mm, width 24mm, thickness 2.0mm
Carrier Tape	Space between: 20mm

Check the humidity indicator card before soldering. The 30% indication is blue under normal conditions, as shown in figure 6-2. Bake modules firstly before soldering if the 30% indication turns pink, as shown in figure 6-3. The UM220-IV M0 modules are rated at MSL level 3, for more MSL information, please refer to www.jedec.org.

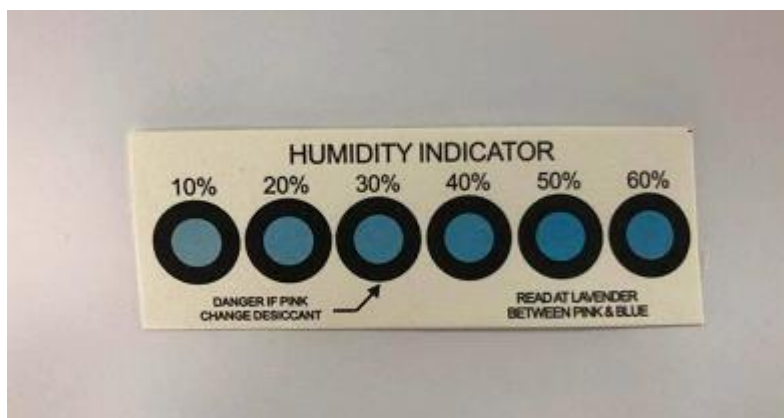

Figure 6-2 the 30% indication is blue

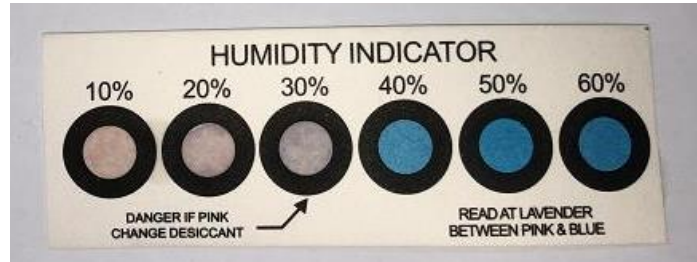

Figure 6-3 the 30% indication is pink

The shelf life of UM220-IV M0 is one year.

7 Clean

Do not use alcohol or other organic solvents to clean, or it may lead to flux residues flooding into the shielding shell, causing mildew and other problems.

8 Reflow Soldering

In order to avoid device falling off, the module should be placed on the top of the main board during welding. Reflow soldering temperature curve is recommended as shown in figure 8-1 below (M705-GRN360 is recommended for solder paste). Note: the module can only be welded once.

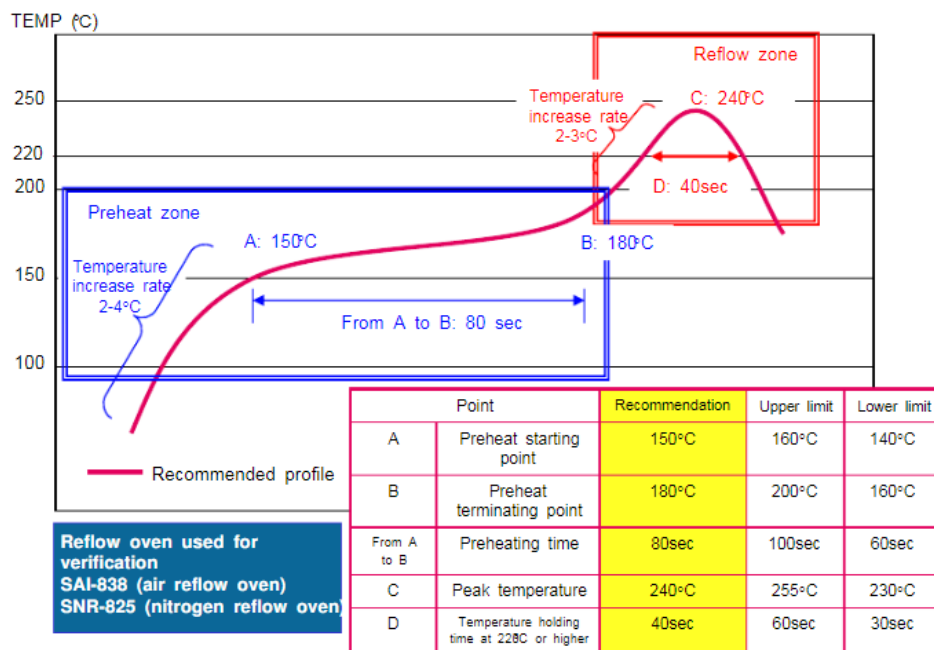

Figure 8-1 Reflow Soldering Line

Note: The apertures in the stencil need to meet the customer's own design requirements and inspection specifications, and the thickness of the stencil should be above 0.15mm, and 0.18mm is recommended.

和芯星通科技（北京）有限公司

Unicore Communications, Inc.

北京市海淀区丰贤东路 7 号北斗星通大厦三层
F3, No.7, Fengxian East Road, Haidian, Beijing, P.R.China,
100094

www.unicorecomm.com

Phone: 86-10-69939800

Fax: 86-10-69939888

info@unicorecomm.com



www.unicorecomm.com